TECHNISCH DOCUMENT

BimITS-S

Inhoud van bibliotheek



Spinnerijstraat 14, B-9240 Zele, België

Tel.: 052/45.72.62

Fax : 052/45.72.63

Website: <http://www.i-theses.com>

E-mail: support@i-theses.com

Copyright 1994-2008 by i-Theses bvba

i-Theses behoudt zich alle rechten voor van intellectuele en industriële eigendommen, met betrekking tot de door i-Theses verschaftte leermiddelen. De cursist is **niet gerechtigd** cursusmateriaal, waarop rechten aan i-Theses toekomend, op enigerlei wijze te vermenigvuldigen, aan derden af te staan of in gebruik te geven.

Datum: 20/09/20010

Revit® is geregistreerd handelsmerk van Autodesk®

Auteur: Dieter Vermeulen

INHOUDSOPGAVE

0.	INHOUDSOPGAVE	3
1.	FUNDERINGEN	5
1.1	Funderingsbalken	5
1.2	Prefab funderingen	6
1.3	Paalfunderingen	7
2.	STAALPROFIELEN	11
2.1	Structural Column	11
2.2	Structural Framing	13
3.	TPG BETON	16
3.1	Structural Column	16
3.2	Structural Framing	17
4.	PREFAB BETON	18
4.1	Structural Column	18
4.2	Structural Framing - balken	21
4.3	Structural Framing – gewelven	24
5.	VERANKERINGEN	25
5.1	Betonverankeringen	25
5.2	Verankeringen voor staalkolommen	26
6.	DETAIL ITEMS	27
7.	ANNOTATIES	28
8.	TITELHOEKEN	29
9.	TEMPLATES	30



FUNDERINGEN

1

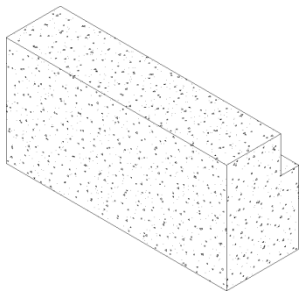
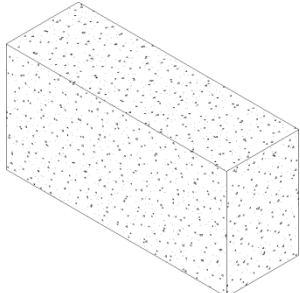
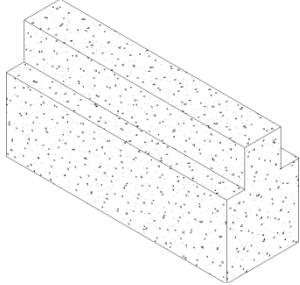
1.1 Funderingsbalken

AFBEELDING	OMSCHRIJVING
	L-vormige funderingsbalk, ter plaatse gestort
	Rechthoekige funderingsbalk, ter plaatse gestort
	T-vormige funderingsbalk, ter plaatse gestort

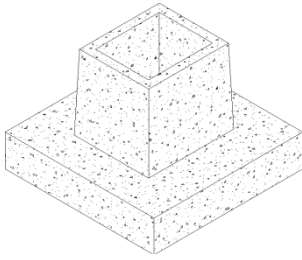
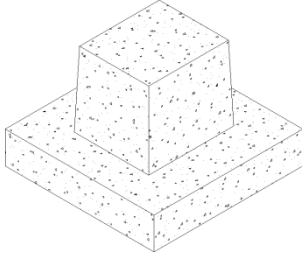
1.2 Prefab funderingen

AFBEELDING	OMSCHRIJVING
	Prefab funderingszool met holle kroon
	Prefab funderingszool met volle kroon
	Prefab funderingsput

1.3 Paalfunderingen

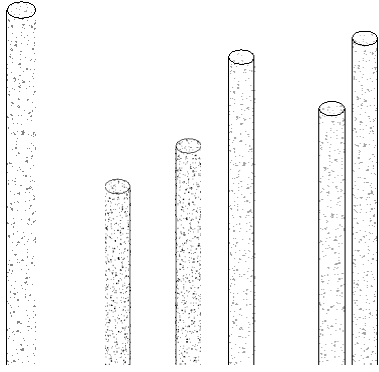
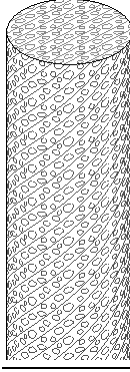
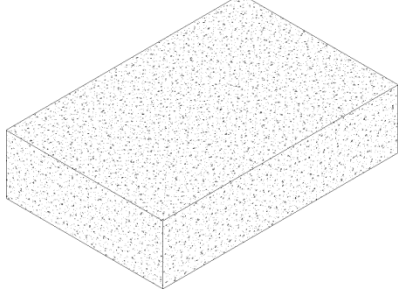
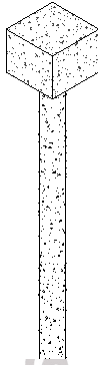
AFBEELDING	OMSCHRIJVING
 A diagram showing three groups of piles. The first group has one pile, the second has two piles, and the third has three piles. Each pile is represented as a vertical cylinder with a stippled texture.	1 / 2 / 3 funderingspalen (in groep)
 A diagram of a cylindrical pile cap, shown as a cylinder with a stippled texture.	Grindkern
 A diagram of a rectangular pile cap, shown as a rectangular block with a stippled texture.	Rechthoekige paalkop
 A diagram of a pile cap with one pile, shown as a rectangular block with a stippled texture, with a single pile extending downwards from its center.	Paalkop met 1 paal

AFBEELDING

OMSCHRIJVING

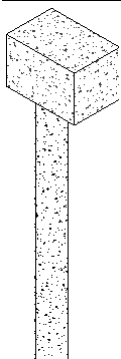

Paalkop met 1 paal, excentrisch

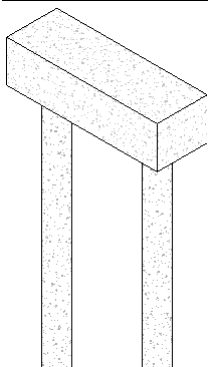

Paalkop met 2 palen

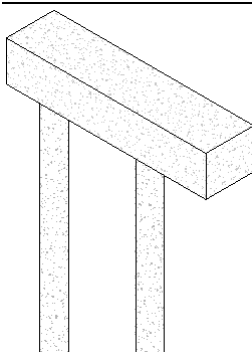

Paalkop met 2 palen, excentrisch

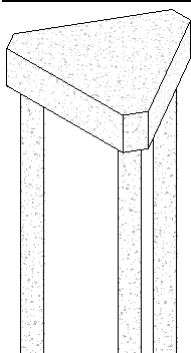

Paalkop met 3 palen, Driehoek - type A

AFBEELDING

OMSCHRIJVING

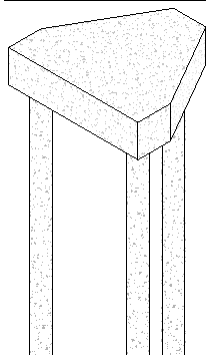

Paalkop met 3 palen, Driehoek - type B

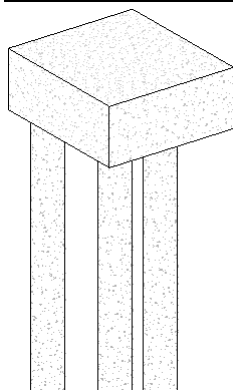

Paalkop met 3 palen, Vierkant

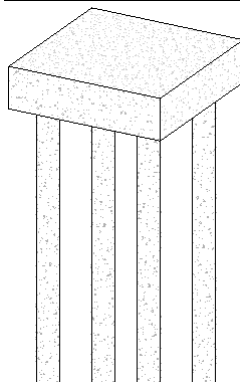

Paalkop met 4 palen

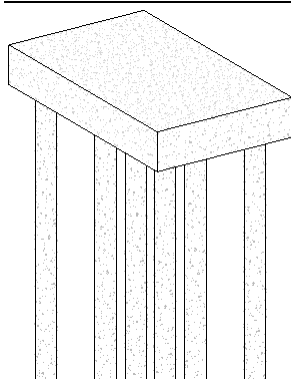

Paalkop met 6 palen

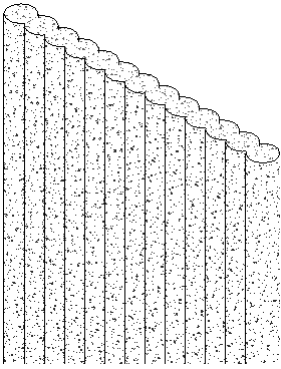



Palenwand

STAALPROFIELEN

2

2.1 Structural Column

AFBEELDING	OMSCHRIJVING
	HE-profiel
	IPE-profiel
	UPN-profiel
	Dubbel UPN-profiel
	Vierkante holle koker

AFBEELDING	OMSCHRIJVING
	Rechthoekige holle koker
	Ronde holle koker

2.2 Structural Framing

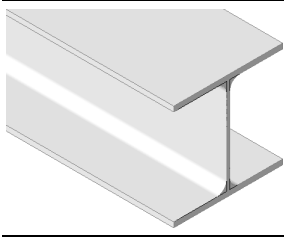
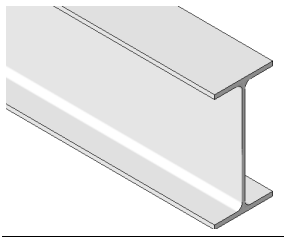
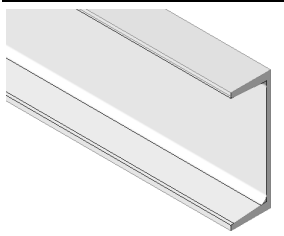
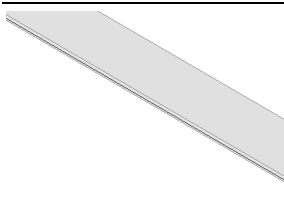
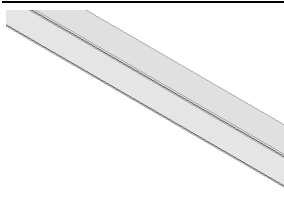
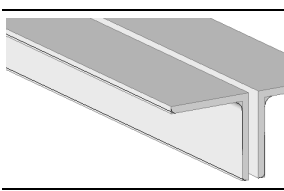
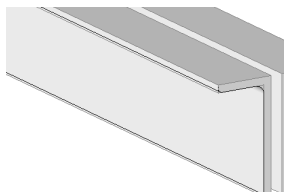
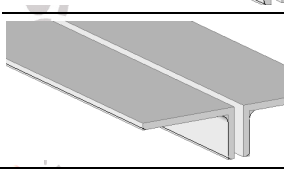

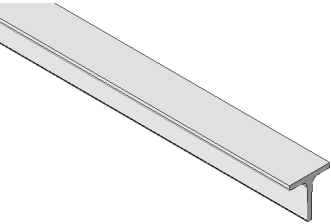
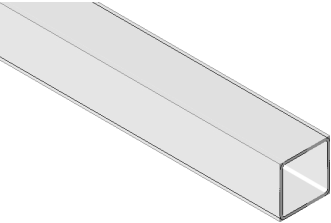
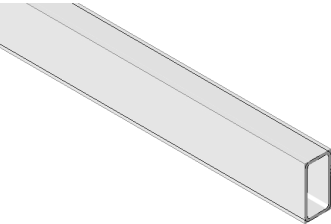
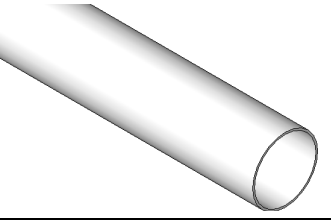
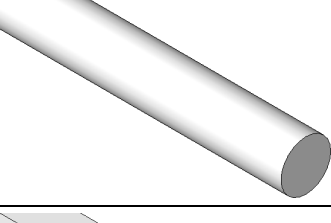
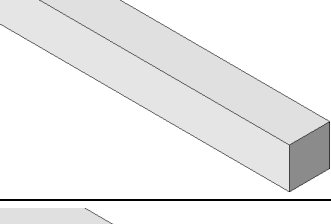
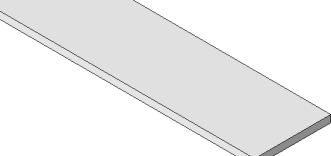
AFBEELDING	OMSCHRIJVING
	HE-profiel (EU 53-62)
	IPE-profiel (EU 19-57)
	UPN-profiel (DIN 1026-1)
	Gelijkzijdig L-profiel (EN 10056-1)
	Ongelijkzijdig L-profiel (EN 10056-1)
	Dubbel gelijkzijdig L-profiel
	Dubbel ongelijkzijdig L-profiel, lange zijde rug-aan-rug
	Dubbel ongelijkzijdig L-profiel, korte zijde rug-aan-rug

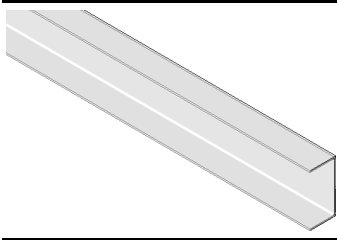
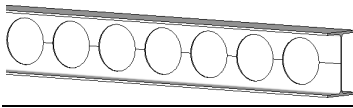
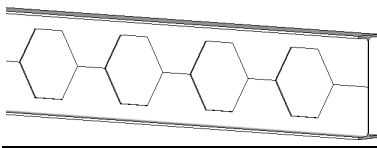
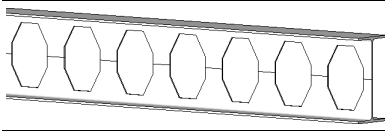
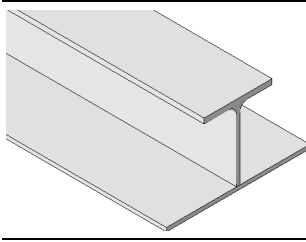
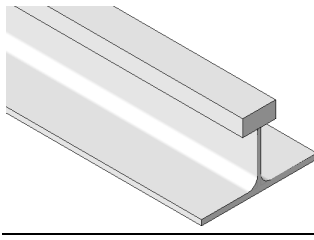
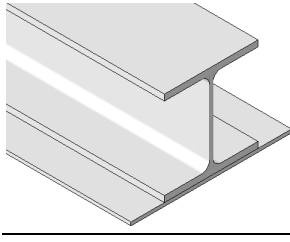
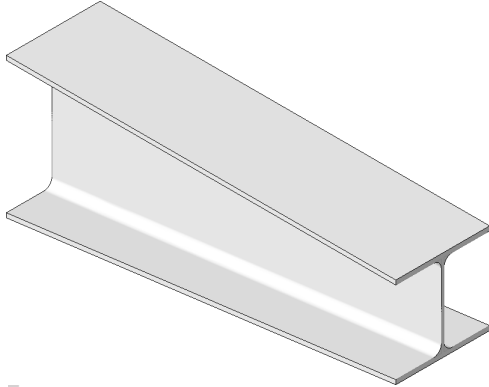
AFBEELDING	OMSCHRIJVING
	T-profiel (EN 10055)
	Vierkante holle koker (EN 10210-2)
	Rechthoekige holle koker (EN 10210-2)
	Ronde holle koker (EN 10210-2 / EN 10219-2)
	Ronde staaf (EN 10060)
	Vierkante staaf (EN 10059)
	Platte plaat (EN 10058)

AFBEELDING	OMSCHRIJVING
	Koudgevormd U-profiel
	Raatligger met ronde openingen
	Raatligger met hexagonale openingen
	Raatligger met octagonale openingen
	Geïntegreerde vloerbalk IFB Type A
	Geïntegreerde vloerbalk IFB Type B
	Slanke vloerbalk SFB
	H-profiel met variabele hoogte



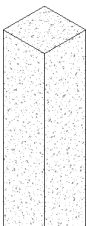
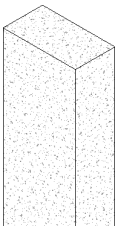
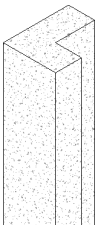
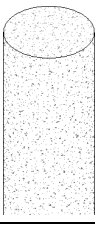

3.1 Structural Column

AFBEELDING	OMSCHRIJVING
	Vierkante kolom
	Rechthoekige kolom
	L-vormige kolom
	Ronde kolom
	O-vormige kolom

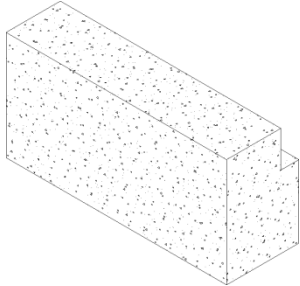
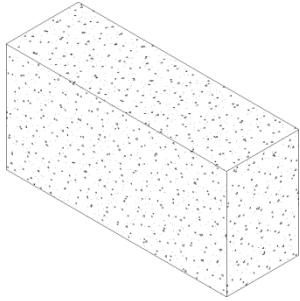
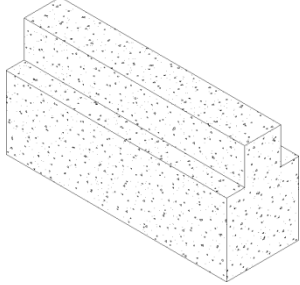
3.2 Structural Framing

AFBEELDING	OMSCHRIJVING
	L-vormige funderingsbalk, ter plaatse gestort
	Rechthoekige funderingsbalk, ter plaatse gestort
	T-vormige funderingsbalk, ter plaatse gestort

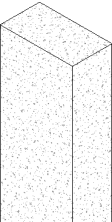
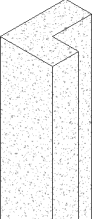
4.1 Structural Column

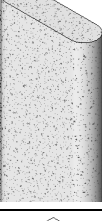
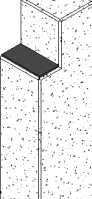
AFBEELDING	OMSCHRIJVING
	Rechthoekige kolom
	L-vormige kolom
	Ronde kolom
	O-vormige kolom
	Rechthoekige kolom met enkele uitsparing

AFBEELDING

OMSCHRIJVING

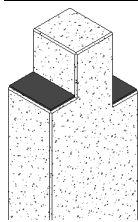

Rechthoekige kolom met dubbele uitsparing

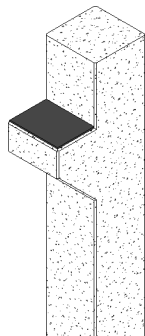

Rechthoekige kolom met 1 console

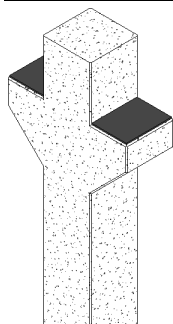

Rechthoekige kolom met 2 consoles

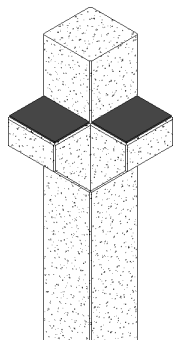

Rechthoekige kolom met 2 consoles, gekruist

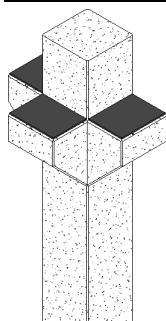

Rechthoekige kolom met 3 consoles

AFBEELDING

OMSCHRIJVING

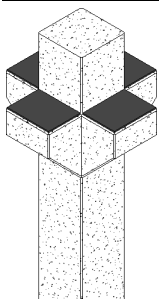

Rechthoekige kolom met 4 consoles

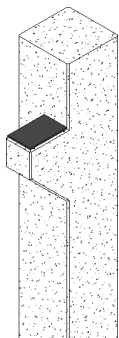

Rechthoekige kolom met 1 halve console

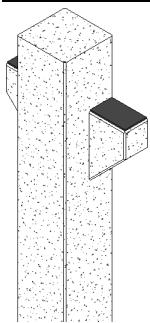

Rechthoekige kolom met 2 halve consoles

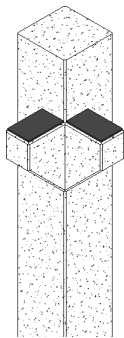

Rechthoekige kolom met 2 consoles, gekruist

4.2 Structural Framing - balken

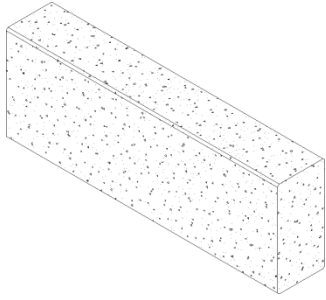
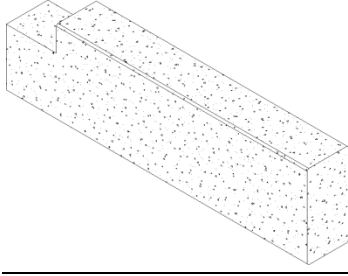
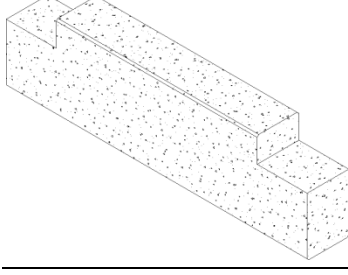
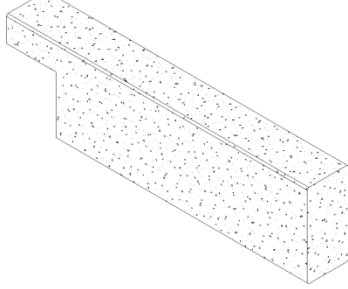
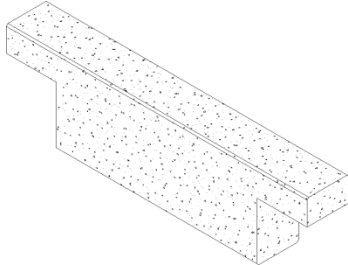
AFBEELDING	OMSCHRIJVING
	Prefab rechthoekige balk
	Prefab rechthoekige balk met enkele uitsparing
	Prefab rechthoekige balk met dubbele uitsparing
	Prefab rechthoekige balk met enkele opleg
	Prefab rechthoekige balk met dubbele opleg

AFBEELDING

OMSCHRIJVING

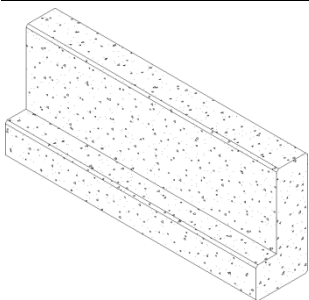

Prefab L-vormige balk

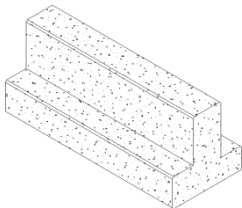

Prefab T-vormige balk

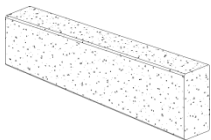

Prefab rechthoekige balk met enkelvoudige helling

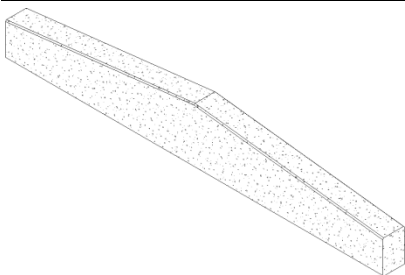

Prefab rechthoekige balk met dubbele helling

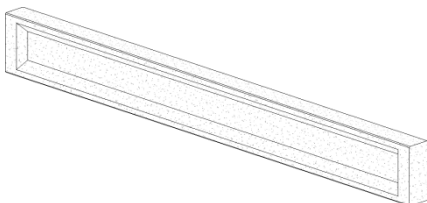

Prefab I-ligger met constante hoogte

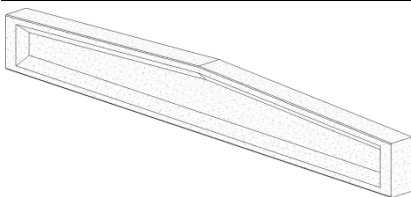

Prefab I-ligger met variabele hoogte

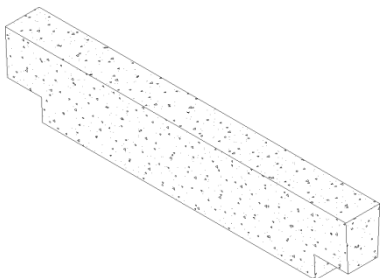

Prefab dakgording

AFBEELDING

OMSCHRIJVING

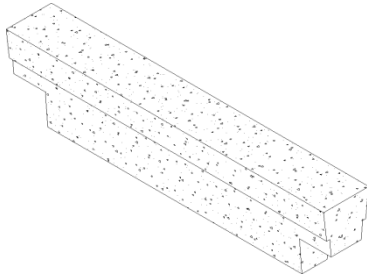

Prefab dakgording met boventafel

4.3 Structural Framing – gewelven

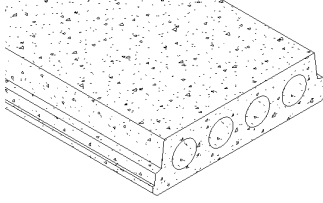
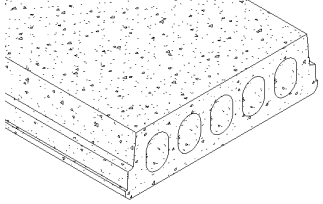
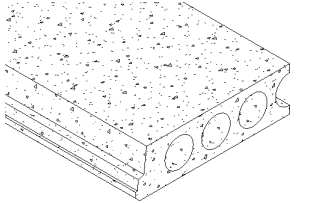
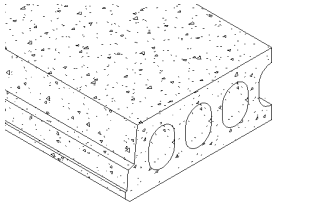
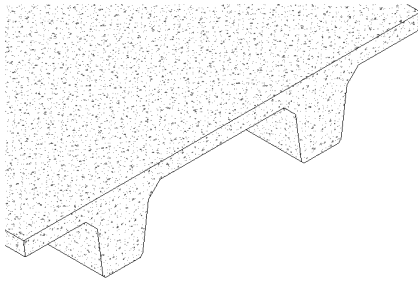
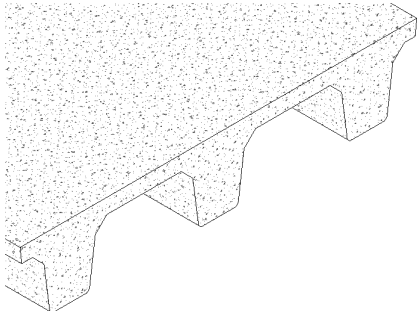
AFBEELDING	OMSCHRIJVING
	Prefab welfsel met ronde openingen, met of zonder isolatie
	Prefab welfsel met ovaal openingen, met of zonder isolatie
	Passtuk prefab welfsel met ronde openingen, met of zonder isolatie
	Passtuk prefab welfsel met ovaal openingen, met of zonder isolatie
	Prefab dakelement met 2 ribben / TT-plaat
	Prefab dakelement met 3 ribben / TT-plaat

VERANKERINGEN

5

5.1 Betonverankeringen

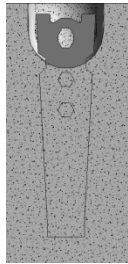

AFBEELDING	OMSCHRIJVING
	Transportanker voor prefab betonelementen
	Transportanker met uitsparing

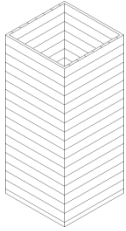
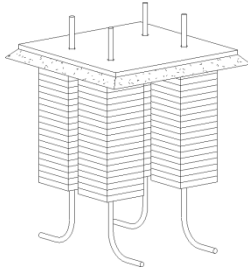
5.2 Verankeringen voor staalkolommen

AFBEELDING	OMSCHRIJVING
 A simple line drawing of a U-shaped steel hook anchor, consisting of a vertical stem and a horizontal hook at the bottom.	Stalen haakanker
 A perspective drawing of a rectangular steel box with a grid of horizontal and vertical reinforcement bars on its sides, representing a Stabox.	Verankeringsdoos (Stabox)
 A perspective drawing of a steel column base. It shows a rectangular steel plate with four vertical reinforcement bars extending upwards. Below the plate, four U-shaped steel anchors are shown extending downwards, secured with nuts and washers.	Stalen kolomvoet met 4 ankers

DETAIL ITEMS

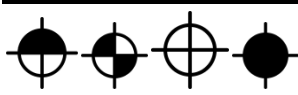
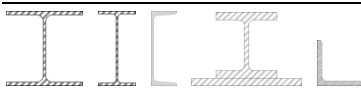
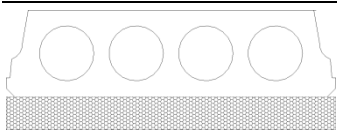
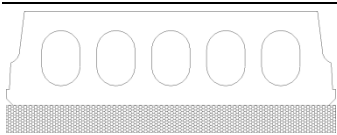
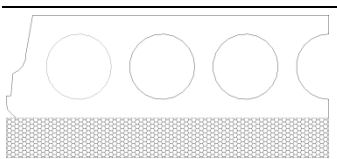
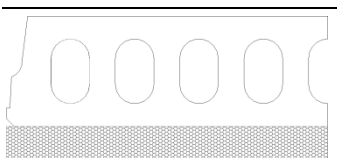
6

AFBEELDING	OMSCHRIJVING
	Paalsymbolen (11 types)
	Staalprofielen (16 types)
	Welfsel met ronde openingen, met of zonder isolatie
	Welfsel met ovalen openingen, met of zonder isolatie
	Passtuk welfsel met ronde openingen, met of zonder isolatie
	Passtuk welfsel met ovalen openingen, met of zonder isolatie
	Betonanker
	Haakanker

ANNOTATIES

7

Beschikbare tags:

- Balken, kolommen, funderingspalen, ...
- Details tags, doorsnedesymbolen
- Spot Elevation symbolen

Alle tags opgemaakt in uniform lettertype : ISOCPEUR

TITELHOEKEN

8

AFBEELDING	OMSCHRIJVING
	<p data-bbox="826 869 1098 898">Titelhoeken, in alle formaten</p>

TEMPLATES

9

AFBEELDING	OMSCHRIJVING
	Materialentemplates voor staal en beton
	i-Theses template voor Structurele tekeningen

Templates opgesteld in uniform lettertype : ISOCPEUR